

CPCD 50/60/70 /85/100 CU1ZG3/CU2ZG3

Configuration			
Parts		High configuration	
Smart safety parts	Tiptronic transmission box	●	
	Electric-hydraulic proportional control valve	●	
	Wet type brake drive axle	●	
	HELI smart safety buffering system	●	
	Hydraulic service brake	●	
	Stepless speed limit from 5km/h to the maximum speed	●	
	OPS	●	
	Stamping overhead guard	●	
	Self lock valve of tilting cylinder	●	
	Smart safe control system	○	
	FICS	○	
	9 inches cyclone air filter with dual cores (with pressure alarm)	●	
	Power switch	●	
	Oil tank with lock	●	
	Fire extinguisher (2kg)	○	
	Comfortable parts	Integrated fingertip operation system	●
		Electro-hydraulic parking brake	●
Full suspension seat		●	
Lowering buffering for rear lifting cylinder, upper buffering for front lifting cylinder		●	
Adjustable steering column		●	
Reversing handle with integrated horn		●	
USB interface		●	
Hydraulic synchronized steering		○	
Environment friendly parts	Instrument identification (card swipe or password for start)	○	
	Fan	○	
	Reversing speaker	○	
	Meet the latest emission requirements(EU V, China III)	●	
Variable piston pump	●		
Load sensing steering	●		
LCD instrument	●		

Configuration		
Parts		High configuration
Cab	Front windshield (with wiper)	○
	Rear windshield	○
	Panel mounted cab	○
	Panel mounted cab (with heater)	○
	Panel mounted cab (with heater and air conditioner for cooling)	○
Lights	Panel mounted cab (with air conditioner for cooling)	○
	Panel mounted cab (with air conditioner)	○
	LED lights for whole truck	●
	LED rear working lights (2)	○
	Warning light (rotating)	○
Lifting system	Warning light (rotating and buzzer)	○
	Blue light	○
	Normal mast	●
	Full free mast (two stage or three stage)	○
	Non-standard attachment	○
	Mast height	○
	Hydraulic fork positioner (8.5-100)	●
	Fork carrier (5-7)	●
	backrest (5-7)	●
	Sharp type fork	○
Others	Winder fork carrier	○
	Metric thread	●
	American thread	○
	Solid tyre	○
	Traceless solid tyre	○
	Sleeve for tilting cylinder	●
Sleeve for steering cylinder	●	
Universal key	○	
Customer made color	○	

Note: "●" standard; "○" optional; "-" non-configuration



5-10 t

G3 series Internal Combustion Counterbalanced Forklift Truck



ANHUI HELI CO., LTD.
Add / No.668, FangXing Road, Hefei, China
Fax / +86-551-63639966

Tel / +86-551-63639068(America); 63639258(Europe);
63639358(Asia); 63662105(Africa & Middle East);
63639530(Key Accounts Division); 63662105(Wheel loader)

HELI

**Our power and confidence are from
reliable high quality products.**

Elegance in appearance,excellent in performance



Ecology and saving

The QSF3.8 Euro V power engine of Cummins is equipped with DOC + DPF + SCR post-treatment technology meeting the most stringent emission standards;



Standard DANFOSS hydraulic variable system and load sensitive steering system are energy saving and high efficiency;

Energy saved by 10%



Smart and comfortable

Standard configuration of ZF tiptronic transmission

- Full time free gear control of front 3 / rear 3 is suitable for complex working conditions;
- The proportional valve can control the gear shift accurately and smoothly, which makes driving comfortable;
- Stepless speed limit from 5km / h to the maximum speed can be realized and it is suitable for different application;
- Electronic control system and gearbox clutch calibration function offer long-term and efficient operation through smart protection on transmission box.

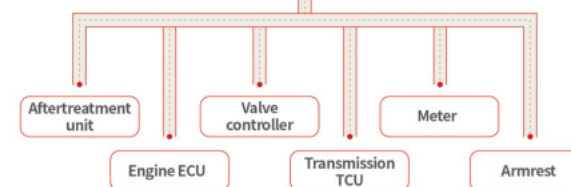

Through LCD instrument and good human-computer interaction, the operator can monitor the truck status in real time.



Electronic architecture based on CAN bus communication

- More concise wiring harness
- More efficient communication
- greatly reduce Communication failure rate, more reliable

HELI smart fleet management system (optional)

Vehicle positioning	Vehicle management
Remote diagnosis	Identification recognition (optional)
Remote monitoring	Weight management (optional)
Maintenance reminder	Collision management (optional)
Statistical form	



Standard configuration of intelligent safety buffer system cushion operator from effects of riding over uneven surface and it is more comfortable.

• Vibration shock reduction

When driving under load conditions, the impact caused by uneven surface is greatly absorbed, and the vibration is effectively reduced.

• Vibration and noise reduction

When driving under load condition, the impact noise caused by uneven surface is greatly reduced.

• Reduced driving fatigue

During the emergency stop operation during the load lowering process, the vibration and driving fatigue caused by inertia impact can be effectively reduced, and the driving safety can be improved.

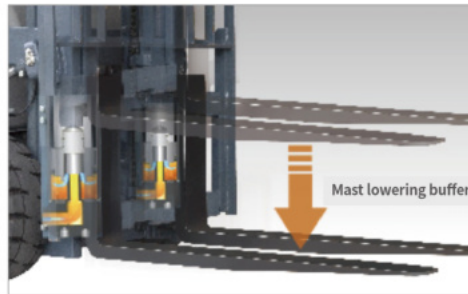
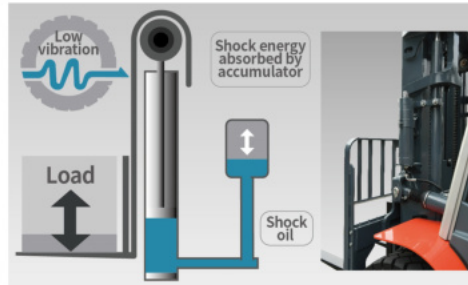

Standard configuration of oil cylinder lower buffer, comfortable operation

Multi system joint optimization design (active noise reduction of engine, transmission box, axle and hydraulic oil pump, application of sealing sound insulation materials of the whole truck) reduces truck noise.

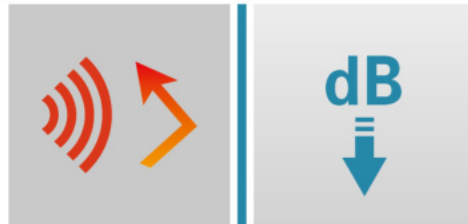

Hydraulic synchronous steering system can adjust steering wheel and wheel angle offset smartly and offers accurate steering and comfortable driving; (optional)

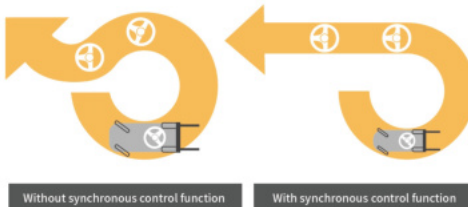

The truck is equipped with hydraulic electronic parking brake to prevent misoperation, the parking brake can be realized by gently touching after the truck stops.



All round man-machine system guarantees comfortable driving: the truck is equipped with armrest, full suspension seat, integrated fingertip operating system and large driving space.



High efficient and safe

Smart protection on gearbox and engine ensure the safety of the whole truck.



Smart protection on high engine water temperature, low oil pressure, intake pressure and temperature

- Operator present system (after the driver leaves the seat accidentally, walking and lifting function of the whole truck is terminated) prevents the potential safety hazards caused by misoperation.
- When parking brake works, truck travel function is prohibited and thus the safety of driving operation is improved;
- Start protection function, fingertip operation system and anti-restart protection function from non-neutral gear ensure operation safety;
- The truck is equipped with large capacity air filter with safety filter element and pressure alarm function;
- The optimal design of power suspension increases the limit of limit impact to protect the power assembly from accidental impact;
- Truck safety warning: reverse image system, warning light, etc. (optional)



- Stamping roof type overhead guard improves the roof strength and improves the operation safety;

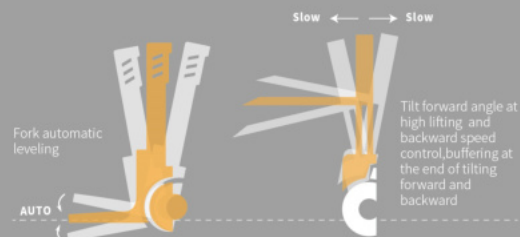

- Intelligent safety control system improves the safety of high-lifting operation; (optional)

G3 series 5-10t internal combustion forklift truck has improved performance and create higher efficiency at fixed working hours.

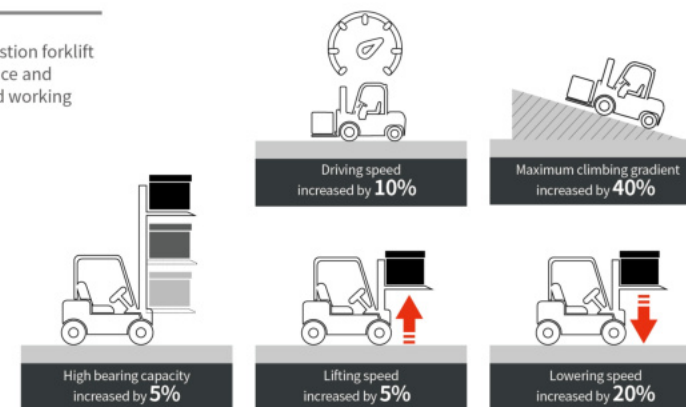

Note: the above data are from the comparison with G series 7t internal combustion forklift truck.

Reliable quality

HELI has been committed to the research of truck reliability for many years, and the core parts have been verified by the market for a long time. The truck goes through high standard reliability test before marketing, long-time quality tracking and verification after marketing, and strict control of various performance indicators.

- The CAE forward design improves the strength of structural parts;
- Wet braking with forced oil cooling radiator ensures the stability and reliability of braking performance under extreme conditions;
- High performance cooling system ensures the heat dissipation performance of the whole truck;

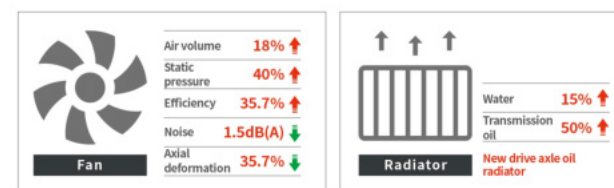
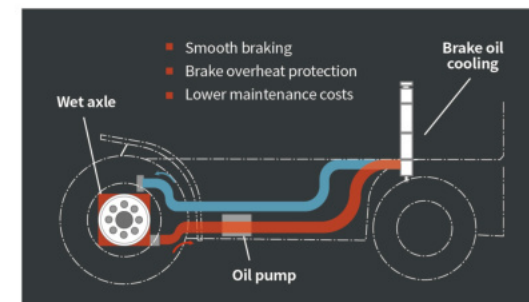

Note: the above data are from the comparison with G series 7t internal combustion forklift truck

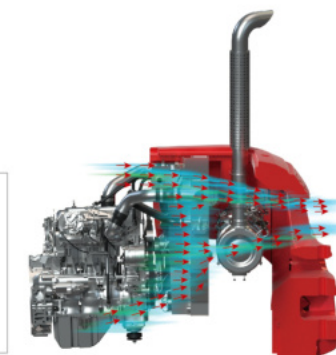

Harsh truck key parts endurance reliability test ensures the long-term reliability of core parts.



Higher standard endurance reliability test and high-intensity industrial verification of the whole truck ensures the reliability of long-term use of the whole truck;

Efficient and convenient maintenance

Super long maintenance cycle of core parts

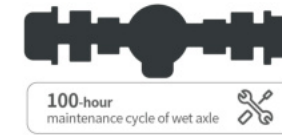
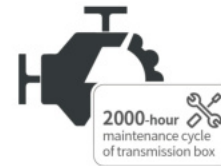

Integrated electrical cabinet and embedded instrument make disassembly and maintenance easy;



Timely remind maintenance information is given through instrument;

Large opening angle hood and detachable front and rear floor make check and repair easier;



Manufacturer and Technical Data													
Characteristics													
1.01	Manufacturer	HELI											
1.02	Model		CPCD50	CPCD60	CPCD70	CPCD85	CPCD100	CPCD50	CPCD60	CPCD70	CPCD85	CPCD100	
1.03	Configuration number		CU1ZG3	CU1ZG3	CU1ZG3	CU1ZG3	CU1ZG3	CU2ZG3	CU2ZG3	CU2ZG3	CU2ZG3	CU2ZG3	
1.04	Rated capacity	Q	kg	5000	6000	7000	8500	10000	5000	6000	7000	8500	10000
1.05	Load center distance	c	mm									600	
1.06	Power mode											Diesel	
1.07	Driving mode											Seat-type	
1.08	Front overhang	x	mm	575	580	585	687	702	575	580	585	687	702
1.09	Wheelbase	y	mm									2300	
Weight													
2.01	Total weight		kg	8470	9000	9860	11600	12800	8470	9000	9860	11600	12800
2.02	Axle load (laden,front/rear)		kg	12000/1470	13390/1610	14930/1930	17700/2400	20300/2500	12000/1470	13390/1610	14930/1930	17700/2400	20300/2500
2.03	Axle load (unladen,front/rear)		kg	4430/4040	4270/4730	4300/5560	4750/6850	5800/7000	4430/4040	4270/4730	4300/5560	4750/6850	5800/7000
Tyres													
3.01	Tyre type			Pneumatic type				Pneumatic type					
3.02	Tyre size,front			8.25-15-14PR				9.00-20-14PR				9.00-20-14PR	
3.03	Tyre size,rear			8.25-15-14PR				9.00-20-14PR				9.00-20-14PR	
3.04	Wheels,number front/rear (x=driven wheels)			4X/2				4X/2				4X/2	
3.05	Tread, front	b10	mm	1520				1600				1520	
3.06	Tread, rear	b11	mm					1700				1600	
Dimensions													
4.01	Mast tilt angle (forward/backward)	α/β	°	6/12				6/12					
4.02	Height (mast lowered)	h1	mm	2480				2700				2850	
4.03	Free lifting height	h2	mm	155	160	165	190	200	155	160	165	190	200
4.04	Lifting height (standard)	h3	mm	3000				3000					
4.05	Max. height,extended (with backrest)	h4	mm	4400				4250				4415	
4.06	Height of overhead guard	h6	mm	2450				2560				2450	
4.07	Seat height relating to SIP (to ground)	h7	mm	1435				1540				1435	
4.08	Towing coupling height	h10	mm	535				600				535	
4.09	Overall length (with fork)	l1	mm	4705	4795	4865	5172	5422	4705	4795	4865	5172	5422
4.10	Overall length (without fork)	l2	mm	3485	3575	3645	3952	4202	3485	3575	3645	3952	4202
4.11	Overall width	b1	mm	2045				2165				2045	
4.12	Fork size:thickness x width x length	s/e/l	mm	55/150/1220	60/150/1220	65/150/1220	70/175/1220	80/175/1220	55/150/1220	60/150/1220	65/150/1220	70/175/1220	80/175/1220
4.13	Fork carriage,according to ISO2328			4A				/				4A	
4.14	Distance across fork-arms, Max./Min.	b5	mm	300-1845				470-1990				470-2100	
4.15	Ground clearance (laden,between mast)	m1	mm	180				250				180	
4.16	Ground clearance (center of wheelbase)	m2	mm	230				325				230	
4.17	Right angle stacking aisle width for pallet 1000 x1200mm crossways	Ast	mm	5000	5060	5125	5517	5842	5000	5060	5125	5517	5842
4.18	Right angle stacking aisle width for pallet 800 x1200mm lengthways	Ast	mm	5200	5260	5325	5717	6042	5200	5260	5325	5717	6042
4.19	Min. outside turning radius	Wa	mm	3225	3280	3340	3630	3940	3225	3280	3340	3630	3940
Performance Data													
5.01	Travel speed (laden/unladen)		km/h	29/31				27/30				27/30	
5.02	Lift speed (laden/unladen)		m/s	495/520	490/520	485/520	390/420	330/350	495/520	490/520	485/520	390/420	330/350
5.03	Lowering speed (laden/unladen)		m/s	510/460				460/360				510/460	
5.04	Max.drawbar pull (laden/unladen)		N	76000	75000	74000	76000	76000	76000	75000	74000	76000	76000
5.05	Max.gradeability (laden/unladen)		%	66/19	57/19	50/19	39/19	35/19	66/19	57/19	50/19	39/19	35/19
Combustion-engine													
6.01	Engine manufacturer/Moel			CUMMINS QSF3.8 Euro V/ T4F				CUMMINS QSF3.8 China Stage III					
6.02	Rated power/Speed		kW/rpm	90/2200				86/2200					
6.03	Max. torque/Speed		Nm/rpm	500/1500				470/1100-1700					
6.04	Cylinder number-bore x stroke			4-102*115				4-102*115					
6.05	Engine displacement		L	3.8				3.8					
6.06	Emission			Euro V/ T4F				China Stage III					
6.07	Transmission geers (front/rear)			Front 3/ Rear 3,automatic shifting (with manual mode)									
6.08	Fuel tank capacity		L	160									
Addition data													
7.01	Service brake/Parking brake			Wet braking / Electrical hydraulic braking									
7.02	Operating pressure for attachments		Mpa	/									

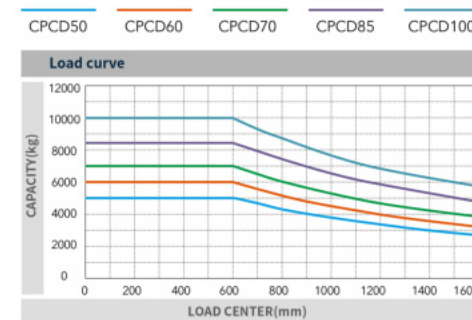
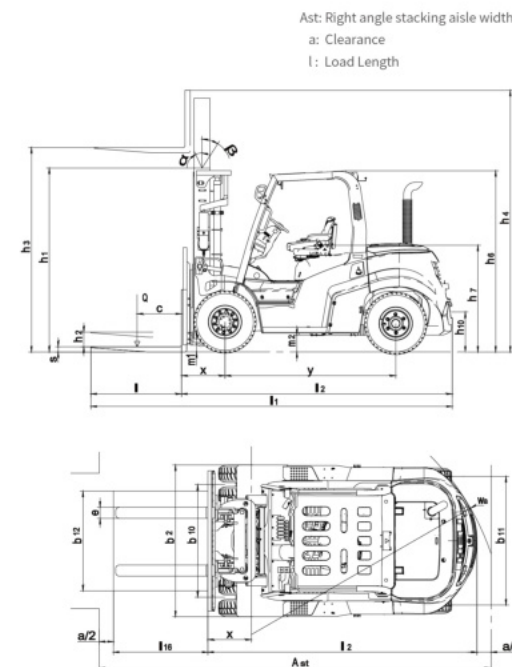

Note: The vertical axis stands for load capacity and the horizontal axis stands for load center which is calculated from the front surface of the forks to the gravity of the standard load. The standard load means a cubic with 1000mm edge length. When mast is tilted forward, using non-standard forks or loading large goods, the load capacity will be reduced. The load capacity of standard mast at different load center can be known from this load chart.

5-7t Wide View Standard Mast

Mast model	Max. fork height (mm)	Load capacity (load center 600mm)(Kg)			Mast height lowered(mm)	Service weight(kg)			Mast tilting angle (°)α/β
		CPCD50	CPCD60	CPCD70		CPCD50/60/70	CPCD50	CPCD60	
M200	2000	5000	6000	7000	2080	8325	8855	9769	6°/12°
M250	2500	5000	6000	7000	2230	8389	8919	9791	6°/12°
M270	2700	5000	6000	7000	2330	8421	8951	9811	6°/12°
M300	3000	5000	6000	7000	2480	8470	9000	9860	6°/12°
M330	3300	5000	6000	7000	2630	8519	9049	9909	6°/12°
M350	3500	5000	6000	7000	2730	8551	9081	9941	6°/12°
M375	3750	5000	6000	7000	2855	8592	9122	9982	6°/12°
M400	4000	5000	6000	7000	3030	8758	9288	10148	6°/12°
M425	4250	5000	6000	7000	3155	8798	9328	10188	6°/12°
M450	4500	5000	6000	7000	3280	8839	9369	10229	6°/12°
M475	4750	5000	6000	7000	3405	8880	9410	10270	6°/6°
M500	5000	5000	6000	7000	3530	8920	9450	10310	6°/6°
M550	5500	4750	5700	6600	3830	9114	9644	10504	6°/6°
M600	6000	4400	5400	6400	4080	9196	9726	10586	6°/6°

8.5-10t Wide View Standard Mast

Mast model	Max. fork height (mm)	Load capacity (load center 600mm)(Kg)		Mast height lowered(mm)		Service weight(kg)		Mast tilting angle (°)α/β
		CPCD85	CPCD100	CPCD85	CPCD100	CPCD85	CPCD100	
M250	2500	8500	10000	2450	2600	10921	12679	6°/12°
M270	2700	8500	10000	2550	2700	10975	12719	6°/12°
M300	3000	8500	10000	2700	2850	11600	12800	6°/12°
M330	3300	8500	10000	2850	3000	11701	12848	6°/12°
M350	3500	8500	10000	2950	3100	11846	12893	6°/12°
M375	3750	8500	10000	3075	3225	11926	12943	6°/12°
M400	4000	8300	10000	3250	3400	12101	13083	6°/12°
M425	4250	8000	10000	3375	3525	12256	13138	6°/12°
M450	4500	8000	9000	3500	3650	12376	13188	6°/12°
M475	4750	8000	9000	3625	3775	12521	13245	6°/6°
M500	5000	7800	9000	3750	3900	12636	13300	6°/6°
M550	5500	7500	8000	4050	4200	12958	13601	6°/6°
M600	6000	7200	7500	4300	4450	13161	13651	6°/6°

5-7t Wide View Full Free 2-Stage Mast

Mast model	Max. fork height (mm)	Load capacity (load center 600mm)(Kg)			Mast height lowered(mm)	Free lift (with backrest)(mm)	Service weight(kg)			Mast tilting angle (°)α/β
		CPCD50	CPCD60	CPCD70			CPCD50/60/70	CPCD50	CPCD60	
ZM250	2500	5000	6000	7000	2210	840	8509	9039	9899	6°/12°
ZM270	2700	5000	6000	7000	2310	940	8546	9076	9936	6°/12°
ZM300	3000	5000	6000	7000	2460	1090	8603	9133	9993	6°/12°
ZM330	3300	5000	6000	7000	2610	1240	8660	9190	10050	6°/12°
ZM350	3500	5000	6000	7000	2710	1340	8697	9227	10087	6°/12°
ZM375	3750	5000	6000	7000	2835	1465	8745	9275	10135	6°/12°
ZM400	4000	5000	6000	7000	3010	1640	8920	9450	10310	6°/12°
ZM425	4250	5000	6000	7000	3135	1765	8972	9502	10362	6°/12°
ZM450	4500	5000	6000	7000	3260	1890	9015	9545	10405	6°/12°
ZM475	4750	5000	6000	7000	3385	2015	9062	9582	10452	6°/6°
ZM500	5000	5000	6000	7000	3510	2140	9099	9629	10489	6°/6°
ZM550	5500	4750	5700	6600	3810	2440	9319	9849	10709	6°/6°
ZM600	6000	4400	5400	6400	4060	2690	9414	9944	10804	6°/6°

Note: (1) 5-6t: the free lift without backrest 260mm increased, (2) 7t: the free lift without backrest 180mm increased.

8.5-10t Wide View Full Free 3-Stage Mast

Mast model	Max. fork height (mm)	Load capacity (load center 600mm)(Kg)		Mast height lowered(mm)		Free lift (with backrest)(mm)		Service weight(kg)		Mast tilting angle (°)α/β
		CPCD85	CPCD100	CPCD85	CPCD100	CPCD85	CPCD100	CPCD85	CPCD100	
ZSM360	3600	7500	8000	2450	2570	1200	1150	12241	13536	6°/12°
ZSM400	4000	7500	8000	2575	2700	1330	1280	12312	13628	6°/12°
ZSM435	4350	7400	7800	2700	2820	1450	1400	12386	13708	6°/12°
ZSM450	4500	7300	7800	2750	2870	1500	1450	12413	13748	6°/6°
ZSM480	4800	7000	7300	2850	2970	1600	1550	12474	13816	6°/6°
ZSM500	5000	7000	7300	2950	3035	1700	1615	12530	13862	6°/6°
ZSM540	5400	6600	6800	3075	3225	1830	1805	12604	13996	6°/6°
ZSM600	6000	5800	6000	3375	3425	2130	2005	12775	14136	6°/6°
ZSM650	6500	5300	5500	3600	3590	2350	2170	12905	14254	6°/6°
ZSM700	7000	4500	4600	3750	3855	2500	2435	12993	14432	6°/6°

Note: 8.5-10t: free lift without backrest.

Note: The service weight in the table is the weight of the truck assembled with XiChai engine.

5-7t Wide View Full Free 3-Stage Mast

Mast model	Max. fork height (mm)	Load capacity (load center 600mm)(Kg)			Mast height lowered(mm)	Free lift (with backrest)(mm)	Service weight(kg)			Mast tilting angle (°)α/β
		CPCD50	CPCD60	CPCD70			CPCD50/60/70	CPCD50	CPCD60	
ZSM360	3600	4500	5600	6200	2335	910	9153	9683	10443	6°/6°
ZSM400	4000	4500	5600	6200	2460	1040	9213	9743	10503	6°/6°
ZSM435	4350	4500	5600	6200	2585	1156	9271	9801	10561	6°/6°
ZSM480	4800	4500	5600	6200	2740	1310	9468	9998	10758	6°/6°
ZSM500	5000	4500	5600	6200	2805	1380	9499	10029	10789	6°/6°
ZSM540	5400	4200	5300	6000	2940	1510	9568	10098	10858	6°/6°
ZSM600	6000	4000	5000	5600	3135	1710	9657	10187	10947	6°/6°
ZSM650	6500	3500	4500	5000	3405	1975	9746	10276	11036	6°/6°
ZSM700	7000	3200	4000	4500	3510	2085	9799	10329	11089	6°/6°

Note: (1) 5-6t: the free lift without backrest 260mm increased, (2) 7t: the free lift without backrest 180mm increased.